

Potentiometer Tutorial

Cornerstone Electronics Technology and Robotics I Week 8

- Electricity and Electronics, **Section 3.5**, Potentiometers:
 - **Potentiometers:** A potentiometer is a type of variable resistor that is used in circuits having low power. They are used to divide voltage and they come with three terminals.
 - Symbol:

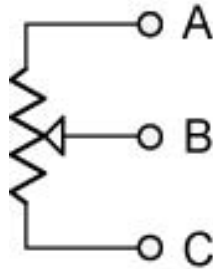

- The resistance between A and C is constant and the value of the potentiometer.
 - The resistance between A and B & B and C changes according to the position of the wiper.
- Construction:

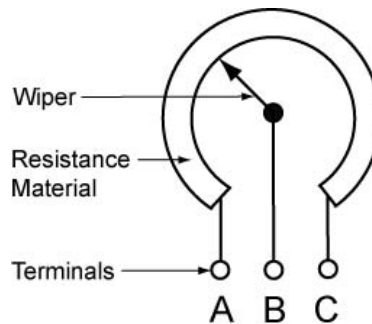

Basic Potentiometer Construction

- Moving the wiper of a potentiometer:

In the figures below, the resistance R_{AC} remains $100\ \Omega$ in all three cases. R_{AB} and R_{BC} change as the wiper rotates.

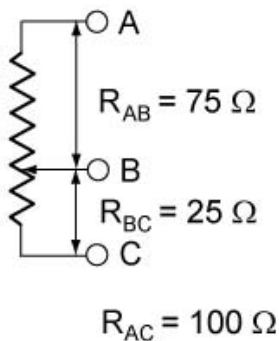

1/4 Turn

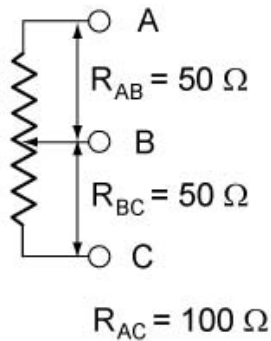

1/2 Turn

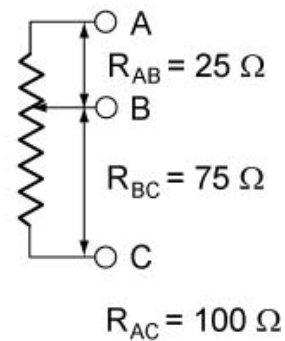

3/4 Turn

- The value printed on a potentiometer is the maximum value (R_{AC}).
- Show samples
- **Tripots** (trimmer potentiometers or trimmers):
 - Small potentiometers with or without knobs.
 - Wear out after as little as one hundred turns.
 - Single vs. multi-turn tripots
 - Values:
 - The first two numbers of the printed value are the two digits of the value. The third digit of the printed value is the number of zeros to add to the end of the first two digits. For example, a tripot labeled 221 has a value of 220 ohms; a tripot labeled 123 has a value of 12,000 ohms.
- Complete Potentiometer Lab 1 – Potentiometers
- **Rheostats:** A 2 terminal variable resistor
 - Symbol:

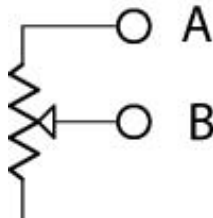

- Any three-terminal potentiometer can be used as a two-terminal variable resistor, by not connecting to the 3rd terminal.
- It is common practice to connect the wiper terminal to the unused end of the resistance track.

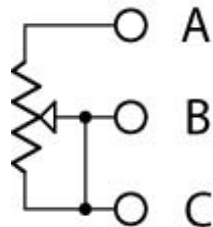

- Complete Potentiometer Lab 2 – Rheostats
- Complete Potentiometer Lab 3 – Brightness Balancing Circuit
- Thermistor:
 - A thermistor is a type of resistor with resistance varying according to its temperature
 - A main advantage of thermistors for temperature measurement is their extremely high sensitivity.
 - Another advantage of the thermistor is its relatively high resistance.

- The major tradeoff for the high resistance and sensitivity of the thermistor is its highly nonlinear output and relatively limited operating range.
- They are used in temperature measuring circuits.
- Complete Potentiometer Lab 4 – Thermistors
- Suggested homework, Student Activity Sheets 3-2, 3-3.

Electronics Technology and Robotics I Week 8 Potentiometer Lab 1 – Potentiometers

- **Purpose:** The purpose of this lab is have the student read tripot values and to help the student understand the function of a potentiometer.

- **Apparatus and Materials:**
 - 7 – Tripots furnished by the instructor
 - 1 – Digital Multimeter
 - 1 – 5 K Ohm Potentiometer

- **Procedure:**
 - Read and record the labeled values of 7 tripots. Measure the resistance of each tripot using a DMM and record its value.
 - Testing potentiometers:
 - Test for maximum resistance of the potentiometer with a DMM, and compare with value printed on the side of the potentiometer.
 - Turn the potentiometer shaft and then flip the DMM leads. How does the maximum resistance value of the potentiometer react?
 - Using the DMM, measure and record the resistance R_{AB} , R_{BC} , and R_{AC} at three different positions of the potentiometer.

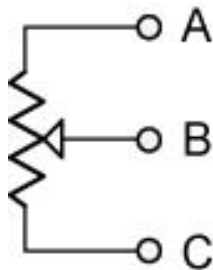

- **Results:**
 - Tripot Values:

Tripot	Printed Value	Measured Value
1		
2		
3		
4		
5		
6		
7		

- Testing potentiometers:

Potentiometer Test			
	Position 1 (Ohms)	Position 2 (Ohms)	Position 3 (Ohms)
R_{AB}			
R_{BC}			
R_{AC}			

- **Conclusions:**

- In the potentiometer test, how does R_{AC} relate to R_{AB} and R_{BC} ?

- Is R_{AC} consistent in the potentiometer test?

Electronics Technology and Robotics I Week 8 Potentiometer Lab 2 – Rheostats

- **Purpose:** The purpose of this lab is to help the student understand the function of a rheostat.
- **Apparatus and Materials:**
 - 1 – Breadboard with a 9 V Power Supply
 - 1 – 25 K Ohm Potentiometer
 - 1 – 470 Ohm Resistor
 - 1 - LED
- **Procedure:**
 - Variable brightness LED circuit:
 - Wire each circuit below, adjust R1, and compare the results.

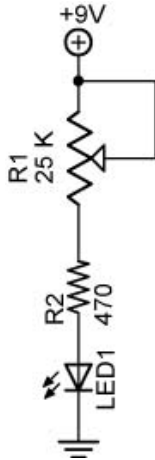

Circuit 1

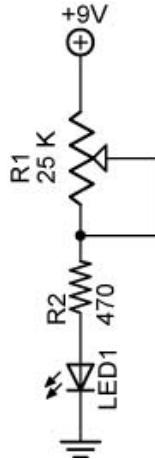

Circuit 2

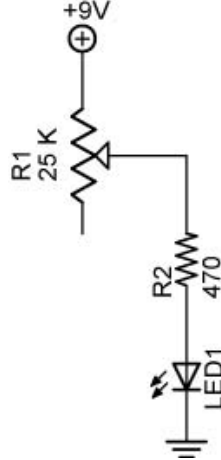

Circuit 3

- **Results:**
- **Conclusions:**
 - Does it matter which of the three circuits is used to control the LED?
 - What is the purpose of the 470 ohm resistor?

Electronics Technology and Robotics I Week 8 Potentiometer Lab 3 – Brightness Balancing Circuit

- **Purpose:** The purpose of this lab is to have the student begin wiring the control circuit for the robot Sandwich.
- **Apparatus and Materials:**
 - 1 – Breadboard with a 9 V Power Supply
 - 2 – DMMs
 - 1 – 500 Ohm Potentiometer
 - 1 – 470 Ohm Resistor
 - 2 - LEDs
- **Procedure:**
 - Wire the breadboard circuit below. Place the circuit on the breadboard as shown in the drawing.

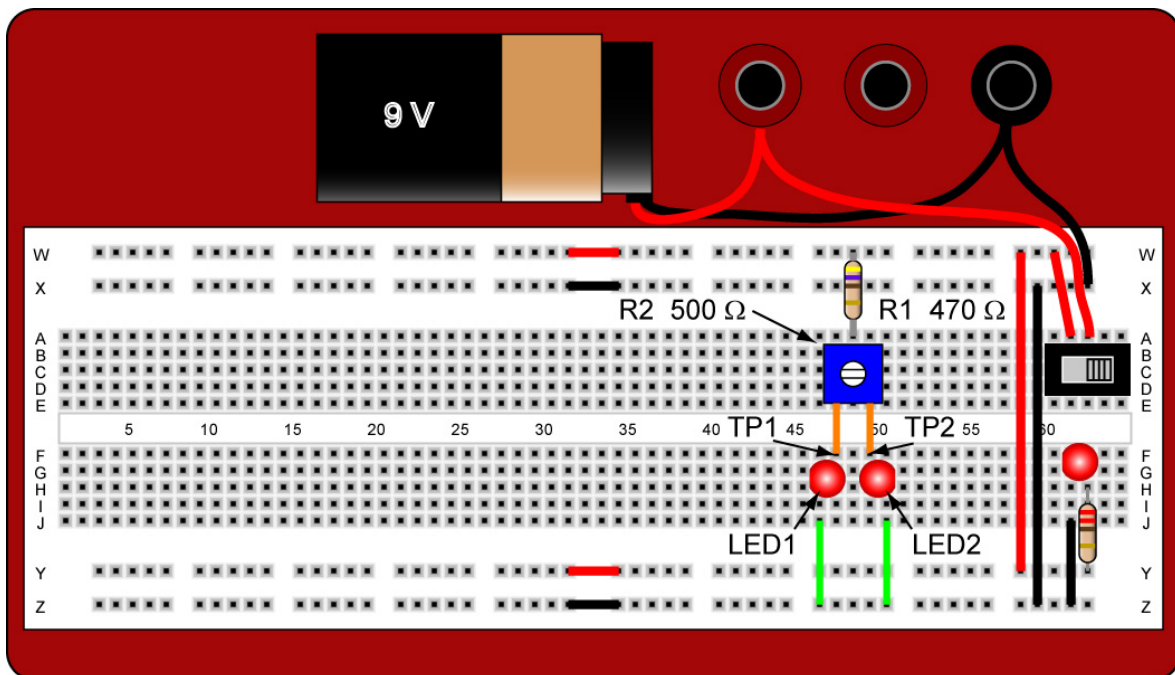

- By measuring the voltages at Test Points 1 and 2, balance the voltage drops across LED1 and LED2.

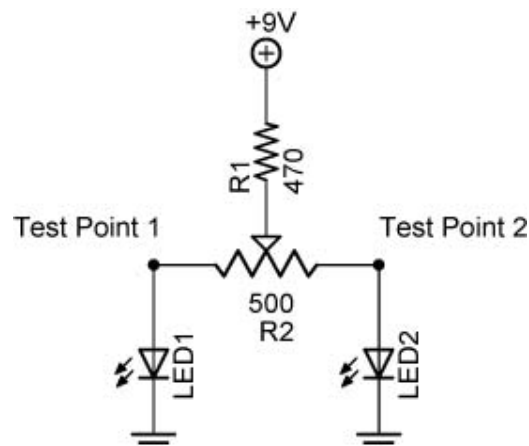

Note: The test points will be used in future lessons.

Electronics Technology and Robotics I Week 8 Potentiometer Lab 4 – Thermistor

- **Purpose:** The purpose of this lab is to acquaint the student with the basic operation of a thermistor.
- **Apparatus and Materials:**
 - 1 – Lab Thermometer
 - 1 – Lab Beaker
 - 1 – DMM
 - 1 – Breadboard with a 9 V Power Supply
 - 1 – Switch
 - 1 – 10 K Ohm Thermistor
 - 1 – 10 K Ohm Resistor
 - 1 – 50 K Ohm Potentiometer
 - 1 – 1 K Ohm Resistor
 - 1 – 741 Op Amp Integrated Circuit
 - 1 - LED
- **Procedure:**
 - First, measure the resistance of the thermistor as it is taken from room temperature and placed in a beaker filled with ice water. Note the changes in resistance as it cools.
 - Now using a 10 K thermistor, wire the thermistor circuit found below.
 - At room temperature, adjust R3 until the LED turns off. Place the thermistor between your fingers to heat it up and to turn on the LED.
 - If the LED remains off, reverse the connections to pins 2 and 3 which will reverse the operation.

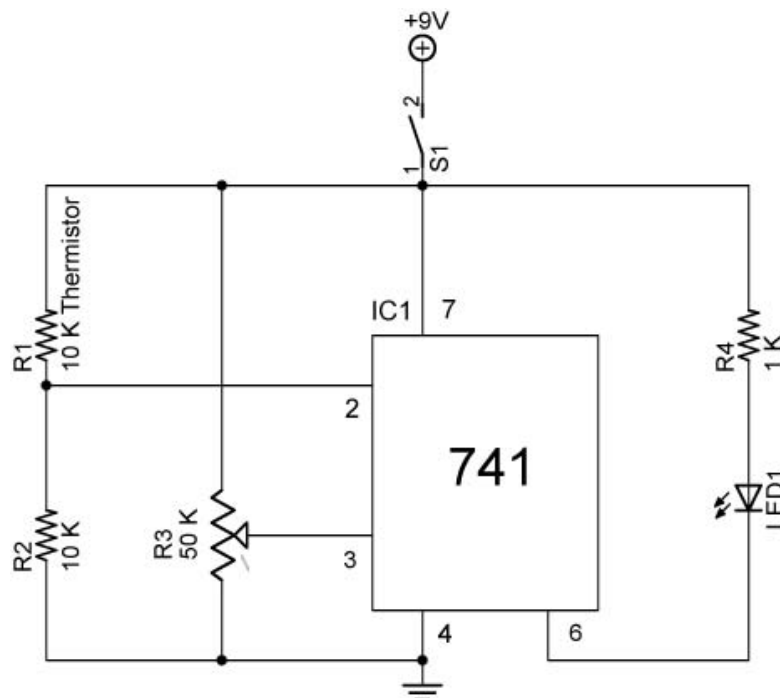

Thermistor Used in an Op Amp Comparator Circuit