

Batteries

Cornerstone Electronics Technology and Robotics I Week 10

- Administration:
 - Prayer
 - Turn in quiz
 - Early arrivals: Measure the current going through the power indicator LED on your breadboard.
- Electricity and Electronics, **Introduction**:
 - Six basic sources of electricity or electromotive force:
 - Friction (covered in Week 1, Statics)
 - Chemical Action (this weeks topic)
 - Light (covered next week)
 - Heat (covered next week)
 - Pressure (covered next week)
 - Magnetism (covered in Week 17)
- Electricity and Electronics, **Section 5.1**, Chemical Action:
 - Volta discovered that when two dissimilar elements were placed in a chemical that reacted upon them, an electrical potential was built up between them.
 - A simple cell consists of two dissimilar metal electrodes with different charges (positive and negative) in a liquid or paste electrolyte solution that contains free floating ions. This combination allows for the transfer or exchange of electrons between the electrodes.
 - Perform Battery Lab 1 – Hand Battery
 - Cells and Batteries:
 - A cell is a single unit that produces a direct current voltage by converting chemical energy into electrical energy. Symbol:

B1

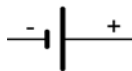

- A battery is a dc voltage source made up of two or more cells. Symbol:

B2

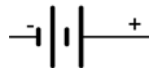

- Batteries in a Circuit:
 - In an electrical circuit, a battery creates a surplus and a lack of electrons through a chemical reaction. The surplus terminal is the (-) terminal and the lacking terminal is the (+) terminal. Attraction and repulsion forces are exerted on the free electrons causing them to move and thus current is created. Remember that unlike charges attract and like charges repel.
 - Unless electrons are flowing from the negative to the positive terminal, the chemical reaction does not take place. Once you connect a wire, the reaction starts. That is why a battery can sit on a shelf for years and still have plenty of power.

- Primary Cells:
 - A primary cell is an electric cell that produces electric current through a chemical reaction which cannot be reversed; a primary cell cannot be recharged.
 - Primary cells are also called dry cells. A dry cell is a cell in which the electrolyte is absorbed into a paper or made into a paste.
 - A battery or generator is like your heart: it moves blood, but it does not create blood.
 - Types of primary cells:
 - Carbon-zinc cell, 1.5v, the standard carbon battery, (carbon and zinc electrodes with an acidic paste electrolyte)
 - Alkaline cell, 1.5v, the Duracell and Energizer batteries, (zinc and carbon electrodes and an alkaline electrolyte)
 - Mercury cell, 1.3v, (mercuric oxide and zinc electrodes and potassium hydroxide electrolyte)
 - Lithium cell, 3.0v, (two mixtures, one-lithium, and two-iron sulfide)
 - Silver oxide cell, 1.5v, (zinc and silver oxide electrodes), this cell is used in aeronautical applications because the power-to-weight ratio is good.
- Perform Battery Lab 2 – Primary Cells
- Secondary cells
 - A secondary cell is an electric cell that produces electric current through a chemical reaction which can be reversed; a secondary cell can be recharged.
 - A secondary cell can be recharged by forcing a current through the battery in the opposite direction of the discharge current.
 - Chemical formulas for lead-acid battery charging:
http://openbookproject.net/electricCircuits/DC/DC_11.html
 - Types:
 - Lead acid cell, 2.0v, used in automobiles, (lead oxide and lead electrodes and sulfuric acid in water electrolyte)

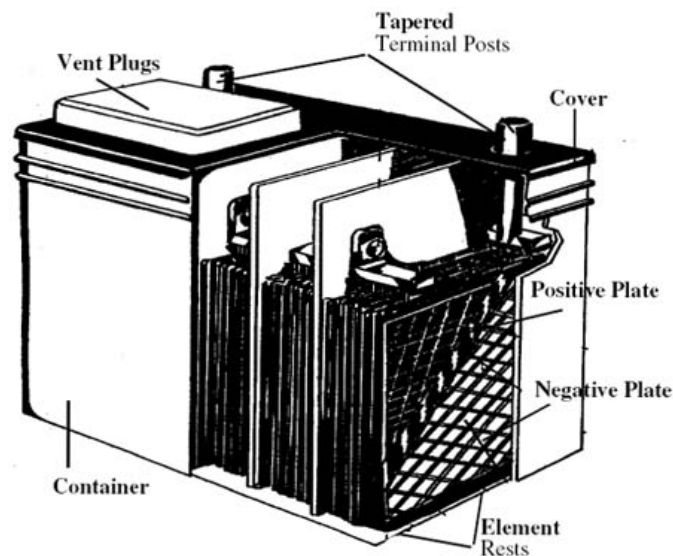

Parts of a Lead Acid Battery

- Nickel-cadmium cell, 1.2v,(nickel salt and cadmium salt plates with a potassium hydroxide electrolyte)
 - Nickel-metal hydride battery - This battery is rapidly replacing nickel-cadmium because it does not suffer from the memory effect that nickel-cadmiums do.
- Safety considerations:
 - Hazards associated with industrial lead-acid batteries:
 - Hydrogen gas
 - Lighter than air
 - Flammable by nature, explosive
 - Can not taste or smell gas vapors
 - Sulfuric acid
 - Burns skin and eyes
 - Shock
 - Weight of the battery
 - Show photo of battery after explosion:
http://www.rayvaughan.com/battery_safety.htm
 - Maintenance-free batteries rely on valves fitted to each cell. Normally any hydrogen and oxygen produced in the cell will recombine into water, but malfunction or misuse may cause gas to build up inside the cell. If this happen (e.g. by overcharging the cell) the valve is designed to vent the gas and thereby normalize the pressure, resulting in a characteristic acid smell around the battery. However, if the valve fails (e.g. blocked by dirt or debris) a dangerous pressure can build up inside the cell. A slight jolt can make a spark jump between the posts and ignite the gas causing an explosion. The force is sufficient to burst the plastic casing or blow the top off the battery, and can injure anyone in the vicinity and spray acid and casing shrapnel to the immediate environment. As a warning, swelling in the cell walls of the battery will occur when the internal pressure rises. The deformation of the walls varies from cell to cell, and is greater at the ends where the walls are unsupported by other cells. It is surprising how powerful an explosion can be caused in the small air space above the electrolyte. When one cell explodes, it sets off a chain reaction in the rest. Such over pressurized batteries should be isolated and discarded, taking great care using protective personal equipment (goggles, overalls, gloves etc) during the handling. From:
<http://www.answers.com/topic/lead-acid-battery-1?cat=technology>
 - Wear personal protection equipment.
 - Safety goggles
 - Rubber gloves
 - Face shield
 - Rubber apron
 - Never open the battery caps with face directly over the battery.
 - Keep sparks and flames away from the battery. Smoking or open flames should never be present in a battery area. Inspect the battery in natural light.
 - Charge batteries in well ventilated space.

- Keep tools and other metallic objects away from uncovered batteries. Never lay tools across the top of a battery. Only use non-conducting tools to remove battery caps.
 - Remove wrist watches, rings, and jewelry which might make electrical contact and create sparks.
 - Wear safety goggles and face shield when working with batteries.
 - If acid does enter the eye, immediately flood with running water for at least 30 minutes. See a doctor as soon as possible.
 - If acid contacts the skin, wash immediately with plenty of water.
 - Do not rub eyes or skin while working with the battery.
 - Wash your hands immediately after completing the job.
 - Clean up all acid spills and flush clothing with a water and baking soda solution.
 - Keep batteries away from children.
 - Store batteries in a cool, dry place. Storage temperature should be between 80°F and 32°F.
 - Don't make live connection directly to the battery. Explosive gases can be set off by a match, incorrect connection of battery cables, and careless use of tools around the battery.
 - Use proper lifting techniques when moving batteries. Batteries are small, but heavy and awkward to lift.
 - See: <http://siri.uvm.edu/ppt/batterysafety/sld001.htm>
- Batteries in series:

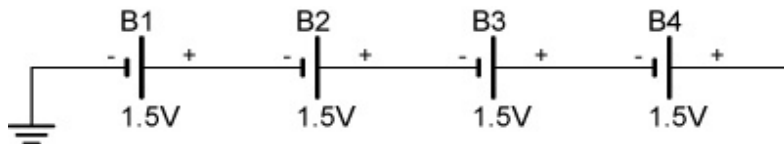

- Voltages are added:

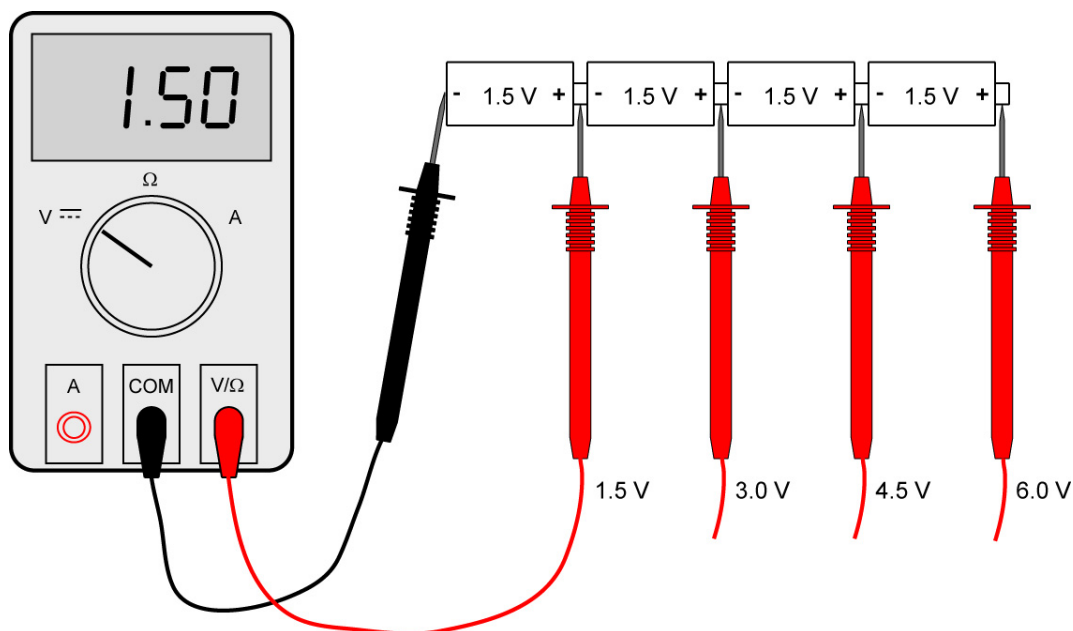

DMM Test Leads Showing Voltages for Batteries in Series

- Amperage is the same

- Batteries in parallel:

- Schematic:

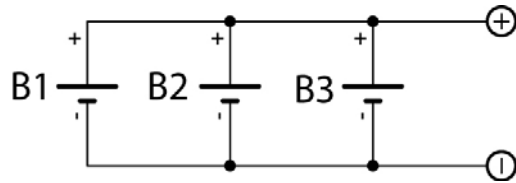

- Voltage is the same:

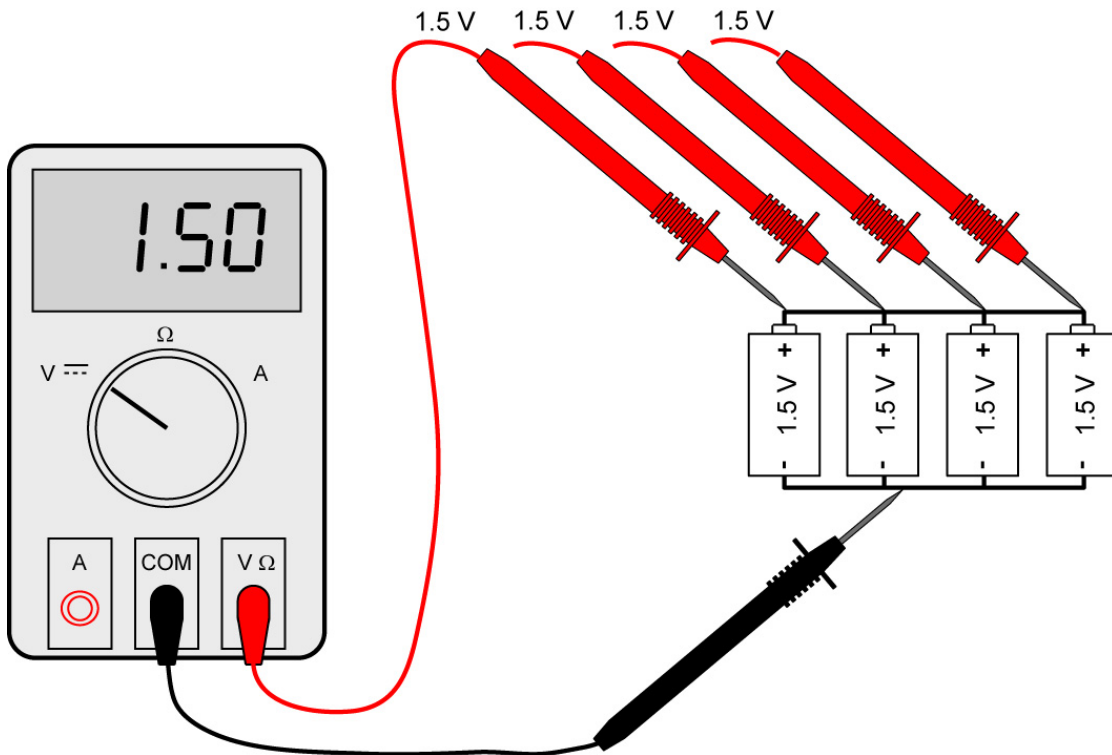

DMM Test Leads Showing Voltages for Batteries in Parallel

- Amperage is added

- Batteries in series and parallel:

- Example schematic:

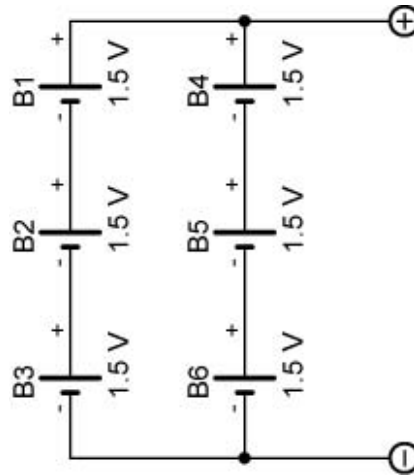

Batteries in Series and Parallel

- The voltages across B1, B2, and B3 are added since they are in series to get 4.5 V. The voltages across B4, B5, and B6 are also added (4.5 V).
 - Since the group B1, B2, and B3 is parallel with the group B4, B5, and B6, the amperages of the two groups add.
 - Perform Battery Lab 3 – Series and Parallel Batteries
 - Combining Batteries to Supply a Negative Voltage:
 - Many circuits require both a positive and negative voltage supply. An audio circuit is such a circuit in that its signals vary between positive and negative voltages relative to the 0 volts reference.
 - The positive and negative voltages can be generated by repositioning the ground between two batteries in series. See the example below.

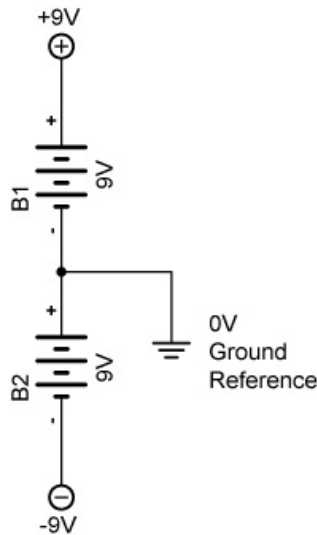

Combining Batteries to Supply a Positive and Negative Voltage

- Perform Battery Lab 4 – Dual Polarity Power Supply

- Battery Capacity:
 - The capacity of a battery is its ability to produce a current over a certain period of time.
 - Because of their limited source of chemical energy, batteries have a limited amount of time they can produce power.
 - Capacity is measured in ampere-hours (Ah) and milliampere-hours (mAh). The ampere-hour rating determines the length of time that battery can deliver a certain amount of current to a load at the rated voltage.
 - A rating of 1 ampere-hour means that the battery can deliver 1 ampere of current to a load for 1 hour at the rated voltage.
 - Ah = Current x Number of Hours
 - Example: How many hours can a battery deliver 7 amperes to a load if the battery has a 56 ampere-hour rating?

$$\text{Hours} = \text{Ah Rating} / \text{Current}$$

$$\text{Hours} = 56 \text{ Ah} / 7 \text{ A}$$

$$\text{Hours} = 8 \text{ hours}$$

- Samples:
 - Approximate amp-hour capacities of some common batteries are given here:
 - Typical automotive battery: 70 amp-hours @ 3.5 A (*secondary cell*)
 - D-size carbon-zinc battery: 4.5 amp-hours @ 100 mA (*primary cell*)
 - 9 volt carbon-zinc battery: 400 milliamp-hours @ 8 mA (*primary cell*)
- Related web sites:
 - http://www.allaboutcircuits.com/vol_6/chpt_3/16.html
 - http://www.allaboutcircuits.com/vol_1/chpt_11/index.html

- Build the following circuit according to the schematic.
 - Circuit from <http://www.techlib.com/electronics/noisemakers.html>

(a) Emergency Siren Simulator

This siren circuit simulates police, fire or other emergency sirens that produce an up and down wail.

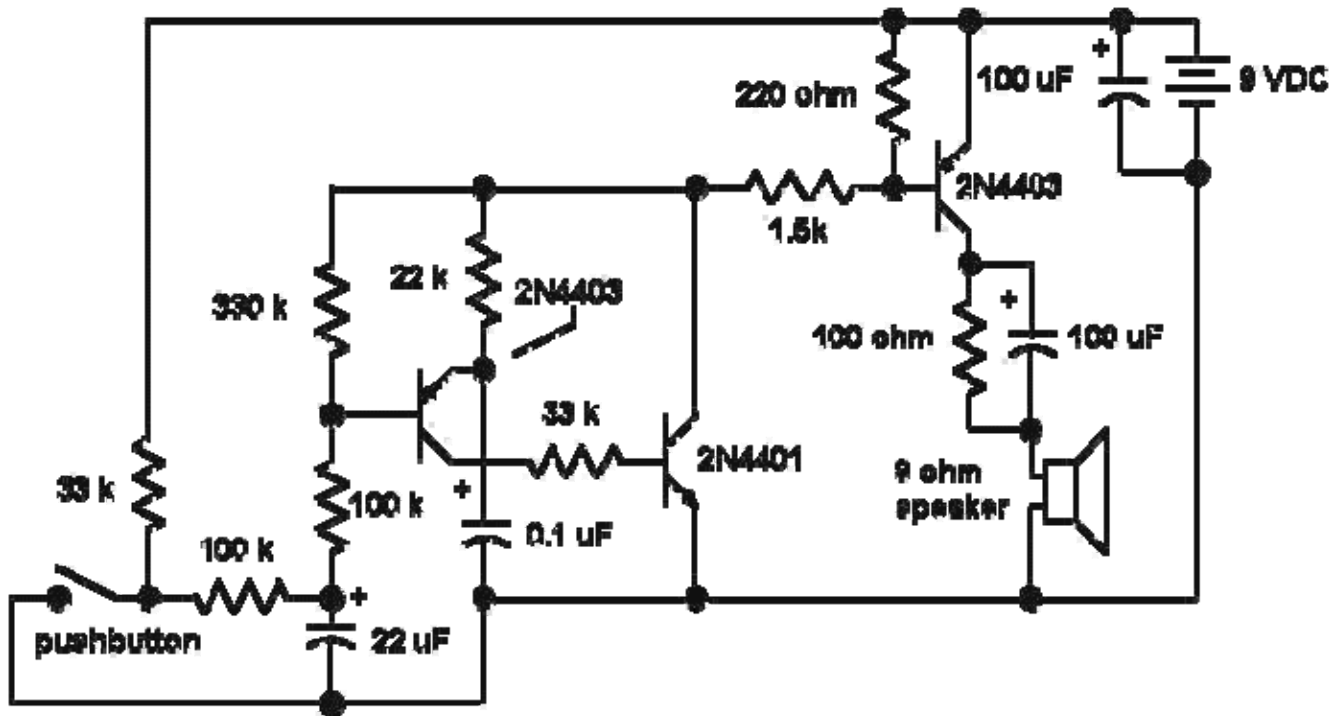

The heart of the circuit is the two transistor flasher with frequency modulation applied to the base of the first transistor. When the pushbutton is depressed, the frequency of oscillation climbs to a peak and when the button is released, the frequency descends due to the rising and falling voltage on the 22 uF capacitor. The rate of change is determined by the capacitor value and the 100k resistor from the pushbutton. The oscillation eventually stops if the button is not depressed and the current consumption drops to a tiny level so no power switch is needed. The 0.1 uF determines the pitch of the siren: A 0.047uF will give a higher pitch siren and a 0.001 uF will give an ultrasonic (at least for me, anyway) siren from 15 to 30 kHz which might have an interesting effect on the neighborhood dogs! The 33k resistor from the collector of the PNP to the base of the NPN widens the pulse to the speaker giving greater volume.

The flasher circuit drives a PNP transistor which powers the speaker. This transistor may be a small-signal transistor like the 2N4403 in most applications since it will not dissipate much power thanks to the rapid on-and-off switching. The 100 ohm and 100uF capacitor in series with the speaker limit the current to about 60 mA and they may be replaced with a short circuit for a louder siren as long as the transistor can take the increased current. The prototype drew about 120 mA when shorted which is fine for the 2N4403.

Transistor substitutions should be fine - try just about any small-signal transistors but avoid high frequency types so that you do not end up with unwanted RF oscillations.

Electronics Technology and Robotics I Week 10

Sources of Electricity Lab 1 – Hand Battery

- **Purpose:** The purpose of this lab is to acquaint the student with the fact that the human body can generate an electrical potential.

- **Apparatus and Materials:**
 - 1 – Digital Multimeter
 - 2 – 5" x 6" Single Sided Copper Clad Circuit Board (Electronix Express # 97BS16)
 - 2 – Aluminum Plate the Size of a Palm
 - Alligator Clips

- **Procedure:**
 - Your skin and two different metals create a battery.
 - Connect an aluminum and a copper plate to the DMM set to 2 volt range. Connect the positive lead to the copper plate.
 - Place one hand on each plate and read the meter.
 - When you touch the two metal plates, the thin film of sweat on your hands acts like the acid in a battery, reacting with the copper plate and with the aluminum plate. In one of these reactions, your hand takes negatively charged electrons away from the copper plate, leaving positive charges behind. In the other reaction, your hand gives electrons to the aluminum plate, causing it to become negatively charged. This difference in charge between the two plates creates a flow of electrical charge, or electrical current.
 - Try using the same type of metal for each plate. Place one hand on each plate and read the meter.
 - You can sometimes get a small current even between two plates made of the same metal. Each plate has a slightly different coating of oxides, salts, and oils on its surface. These coatings create slight differences in the surfaces of the metals, and these differences can produce an electrical current.

- **Results:**
 - Copper/aluminum maximum voltage generated: _____ V
 - Copper/copper maximum voltage generated: _____ V
 - Aluminum/aluminum maximum voltage generated: _____ V

- **Conclusions:**

Electronics Technology and Robotics I Week 10

Sources of Electricity Lab 2 – Primary Cells

- **Purpose:** The purpose of this lab is to acquaint the student with several common household items that can produce an electrical potential.
- **Apparatus and Materials:**
 - 1 – Digital Multimeter
 - 1 – Potato
 - 1 – #16 hot-dipped galvanized nail
 - 1 – # 6 bare copper wire
 - 1 – LED
 - 1 – Lemon
 - Several Pennies, Nickels, and Dimes
 - Salt Water Solution
 - Paper Towels
 - 1 – Lasco Dry Cell Kit
- **Procedure:**
 - Construct several voltaic cells that convert chemical energy into electrical energy:
 - Potato: Insert a #16 hot-dipped galvanized nail and a # 6 bare copper wire into the potato. Measure and record the voltage across the electrodes.
 - Lemon/grapefruit: Insert a #16 hot-dipped galvanized nail and a # 6 bare copper wire into the lemon. Measure and record the voltage across the electrodes.
 - Create a voltaic pile using coins and paper towels. Mix salt with water (as much salt as the water will hold) and soak the paper towel in this brine. Then create a voltaic cell by stacking a nickel, paper towel, and penny in the order as shown below. Measure the voltage across the cell. Try a second layer and measure the voltage the pile produces. Then try making a cell using a nickel and dime and measure the voltage.

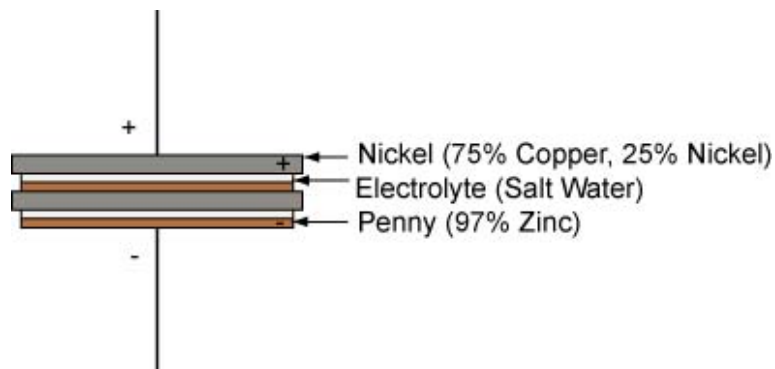

Voltaic Pile

- Dry cell
 - Assemble a dry cell using Lasco dry cell kit and instructions.
 - A dry cell is a cell with a pasty electrolyte. A wet cell, on the other hand, is a cell with a liquid electrolyte.

- **Results:**

- Potato (one) voltage: _____ V
- Lemon/grapefruit voltage: _____ V
- Voltaic pile (nickels and pennies) voltage:

Nickel/Penny Voltaic Pile	
# Layers	Voltage
1	
2	

- Voltaic pile (nickels and dimes) voltage: _____ V
- Dry cell voltage: _____ V

Electronics Technology and Robotics I Week 10
Sources of Electricity Lab 3 – Series and Parallel Batteries

- **Purpose:** The purpose of this lab is to acquaint the student with how voltages add when placed in series and parallel.
- **Apparatus and Materials:**
 - 1 – Digital Multimeter
 - 4 – AA Batteries and Battery Holders
 - TBD – Potatoes
 - TBD – #16 hot-dipped galvanized nail
 - TBD – # 6 bare copper wire
 - 1 – LED
 - Alligator Leads
- **Procedure for Series Batteries:**
 - Connect the four AA batteries as shown in the schematic.

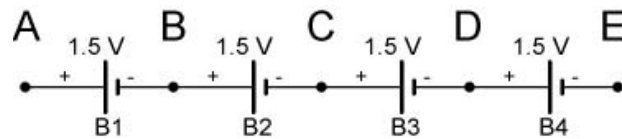

Batteries in Series

- Measure and record the voltages V_{AB} , V_{BC} , V_{CD} , and V_{DE} .
- Calculate the voltages V_{AC} , V_{AD} , and V_{AE} then measure and record the same voltages.
- Compare the calculated and measured results in the conclusions.
- **Results for Series Batteries:**

Individual Voltage	Measured	Added Voltage	Calculated	Measured
V_{AB}		V_{AB}	-	
V_{BC}		V_{AC}		
V_{CD}		V_{AD}		
V_{DE}		V_{AE}		

- **Procedure for Parallel Batteries:**
 - Connect the four AA batteries as shown in the schematic and measure V_{AB} .

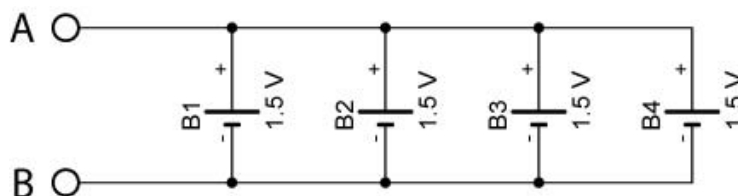

- Remove one battery at a time and measure and record V_{AB} .

- **Results for Parallel Batteries:**

V_{AB} Measured	Batteries Connected
	B1, B2, B3, B4
	B1, B2, B3
	B1, B2
	B1

- **Procedure for Parallel and Series Batteries:**

- Take a potato and insert a #16 hot-dipped galvanized nail and a # 6 bare copper wire to create a “potato cell”.
- Experiment to find a combination of potato cells in series and parallel that provides enough voltage and current to light an LED.

- **Results for Parallel and Series Batteries:**

- Draw the schematic of the battery layout used to light the LED.

- **Conclusions:**

- Batteries in Series:
 - Compare the calculated and measured results in the batteries in series experiment.
 - Do the experimental results conform to the formula for batteries in series?
- Batteries in Parallel:
 - Do the experimental results conform to the formula for batteries in parallel?

Electronics Technology and Robotics I Week 10

Sources of Electricity Lab 4 – Dual Polarity Power Supply

- **Purpose:** The purpose is to acquaint the student with a power supply that furnishes both positive and negative voltages, a dual polarity power supply.
- **Apparatus and Materials:**
 - 2 - 9 V Batteries
 - 2 – 9 V Battery Snaps
 - 1 - Digital Multi-Meter
 - 1 – Alligator Clip Test Lead
- **Procedure:**
 - Use the battery arrangement below to supply +9V and -9V. Connect batteries together using one alligator clip test lead.
 - Use the DMM to verify voltage values shown below. Attach the black common DMM lead to ground for both measurements.

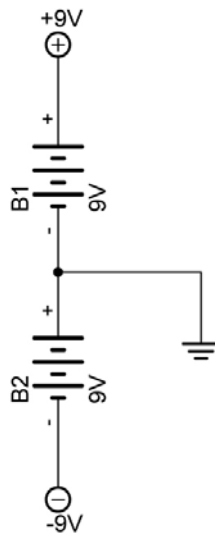

- **Notes:**
 - This power supply circuit could be used in the audio amplifier circuit in LAB 4.